

Investor Relations Presentation Q3 2024

Published October 31, 2024



Safe Harbor Statement

The following information contains, or may be deemed to contain, “forward-looking statements” (as defined in the U.S. Private Securities Litigation Reform Act of 1995). The words “believe,” “expect,” “anticipate,” “intend,” “estimate” and other expressions that are predictions of or indicate future events and trends and that do not relate to historical matters identify forward-looking statements. You should not place undue reliance on these forward-looking statements. Although forward-looking statements reflect management’s good faith beliefs, reliance should not be placed on forward-looking statements because they involve known and unknown risks, uncertainties and other factors, which may cause actual results, performance or achievements to differ materially from anticipated future results, performance or achievements expressed or implied by such forward-looking statements. Forward-looking statements speak only as of the date the statements are made. We undertake no obligation to publicly update or revise any forward-looking statement, whether as a result of new information, future events, changed circumstances or otherwise. These forward-looking statements are subject to numerous risks and uncertainties, including, but not limited to: our participation in markets that are competitive; our ability to prepare for, respond to and successfully achieve our objectives relating to technological and market developments, competitive threats and changing customer needs, including with respect to electric hybrid and fully electric commercial vehicles; increases in cost, disruption of supply or shortage of labor, freight, raw materials, energy or components used to manufacture or transport our products or those of our customers or suppliers, including as a result of geopolitical risks, wars and pandemics; global economic volatility; general economic and industry conditions, including the risk of recession; labor strikes, work stoppages or similar labor disputes, which could significantly disrupt our operations or those of our principal customers or suppliers; the highly cyclical industries in which certain of our end users operate; uncertainty in the global regulatory and business environments in which we operate; the concentration of our net sales in our top five customers and the loss of any one of these; the failure of markets outside North America to increase adoption of fully automatic transmissions; the success of our research and development efforts, the outcome of which is uncertain; U.S. and foreign defense spending; risks associated with our international operations, including acts of war and increased trade protectionism; the discovery of defects in our products, resulting in delays in new model launches, recall campaigns and/or increased warranty costs and reduction in future sales or damage to our brand and reputation; our ability to identify, consummate and effectively integrate acquisitions and collaborations; and risks related to our indebtedness.

Allison Transmission cannot assure you that the assumptions made in preparing any of the forward-looking statements will prove accurate or that any long-term financial goals will be realized. All forward-looking statements included in this presentation speak only as of the date made, and Allison Transmission undertakes no obligation to update or revise publicly any such forward-looking statements, whether as a result of new information, future events, or otherwise. In particular, Allison Transmission cautions you not to place undue weight on certain forward-looking statements pertaining to potential growth opportunities or long-term financial goals set forth herein. Actual results may vary significantly from these statements.

Allison Transmission’s business is subject to numerous risks and uncertainties, which may cause future results of operations to vary significantly from those presented herein. Important factors that could cause actual results to differ materially are discussed in Allison Transmission’s Annual Report on Form 10-K for the year ended December 31, 2023.

Business Overview

Leading designer and manufacturer of propulsion solutions for commercial and defense vehicles

- World's largest manufacturer of medium- and heavy-duty fully automatic transmissions
- Established supplier of fully-integrated commercial-duty electrified propulsion systems

Premier brand, offering superior performance, frequently specified by end users

- Premium price component
- Differentiated technology
- Lower total cost of ownership

Well positioned for revenue and earnings growth

- Further adoption outside North America
- Expanding addressable market
- Funded growth opportunities in asset-light business model
- \$400 million of incremental annual revenue opportunities

Strong cash flow generation and well-defined capital allocation policy

- History of strong free cash flow generation
- Capital allocation priorities include: investing to grow the business, strategic acquisition priorities, and returning cash to shareholders

LTM⁽¹⁾ Net Sales by End Market

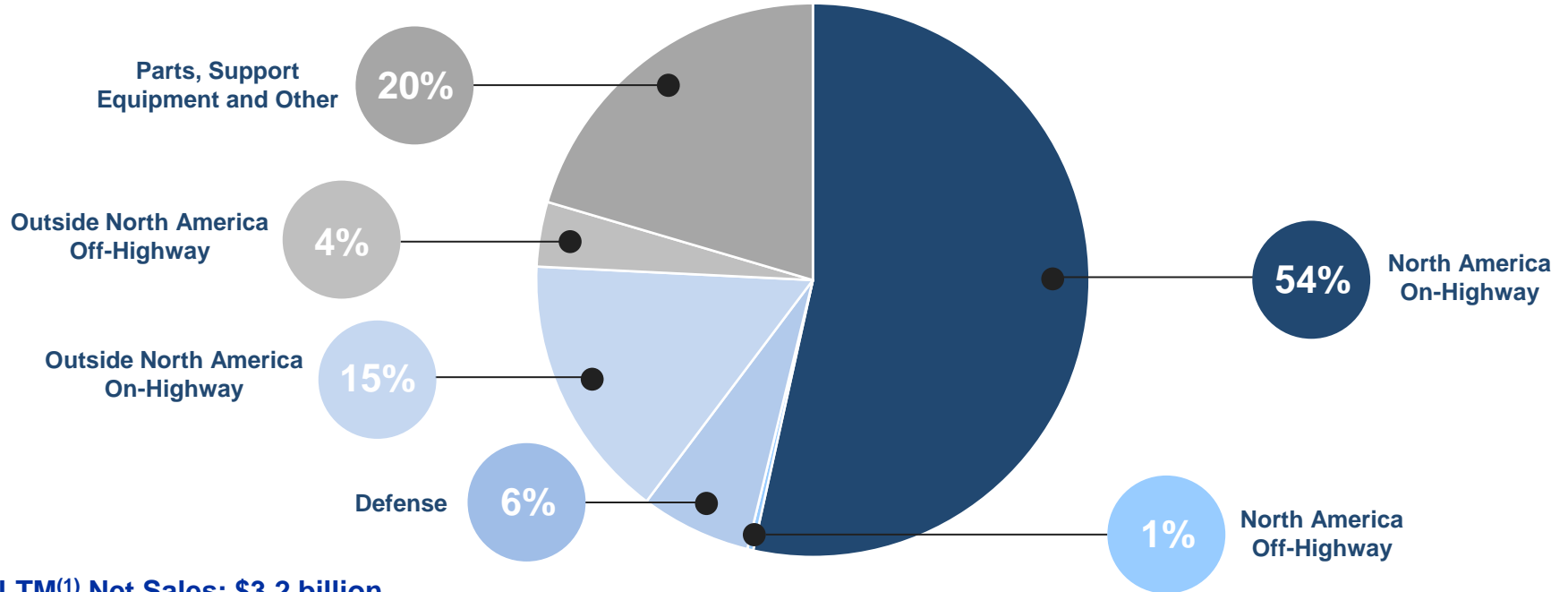









LTM⁽¹⁾ Net Sales: \$3.2 billion

(1) LTM 9/30/24

North America On-Highway End Market



	Class 1-3	Underserved	Core Addressable Market				Underserved	Class 8 Tractor Sleeper (Linehaul)
		Class 4-5	Motor Home	School Bus	Class 6-7	Class 8 Straight	Class 8 Tractor Day Cab	
Vehicles								
Weight (000s of lbs)	<14 lbs	14-19 lbs	16-33 lbs	16-33 lbs	19-33 lbs	33 lbs+	33 lbs+	33 lbs+
Industry Units Produced (2023)	12,565,903	127,832	10,880	31,988	117,082	93,451	109,026	146,861
Allison Share 2023	0%	15%	33%	79%	79%	82%	5%	0%

- ~30-40% of Allison's North America On-Highway market volume is driven by municipal spending, reducing end-market volatility
- Opportunity to further grow share in Class 6/7 with All-New Mack MD Series and Isuzu F-Series medium-duty truck models, exclusively featuring Allison fully automatic transmissions
- Increased infrastructure spending and construction will support demand for Class 8 ST opportunities
- \$100 million incremental annual revenue growth opportunity in the Class 8 Tractor Day Cab market with the Allison 4000 Series™ fully automatic transmission and the award-winning Allison 3414 Regional Haul Series™(1) fully automatic transmission, with proprietary xFE and FuelSense® 2.0 technology, launched with International in 2020, and Daimler Trucks North America (paired with diesel engine) and Volvo Trucks North America in 2021. Further releases in 2023 with Daimler Trucks North America, paired with natural gas engine in their Freightliner Cascadia and diesel engine in their M2 truck.

Note: Analysis excludes Allison's Transit/Coach Bus, and Electric Hybrid Transit Bus volume. Class 8 Straight industry units include Dockspotters.
 Sources: Class 1-3 from WardsAuto North America Production (December 2023); Core Addressable Market from Allison Backcast, and Class 8 Tractor from Allison and ACT Research *State of the Industry* (January 2024)
 (1) Addressable market for the 3414 Regional Haul Series™ (RHS) consists of approximately 25,000 units within the Class 8 Tractor Day Cab segment.

Strategic Priorities



1000/2000 Series™



3000 Series™



4000 Series™



FracTran®



eGen Force™



eGen Power® Electric Axles

Expand global market leadership

- Capitalize on improving developed markets demand
- New vocational offerings to expand addressable market
- Fully-integrated electrified propulsion solutions

Emerging markets penetration

- Automaticity, fuel efficiency and safety trends
- Lower total cost of ownership
- Increasing number of vehicle releases

Continued focus on new technologies and product development

- Alternative fuels and electrified propulsion
- Advanced fuel efficient and emissions reduction technologies
- Enhancements to core technologies for new products and variants

Deliver strong financial results

- Exploit capacity availability and asset-light business model
- Earnings growth and cash flow generation
- Focus on margin sustainment
- Well-defined capital allocation policy

Elite EBITDA Margin



2023 EBITDA Margin⁽¹⁾

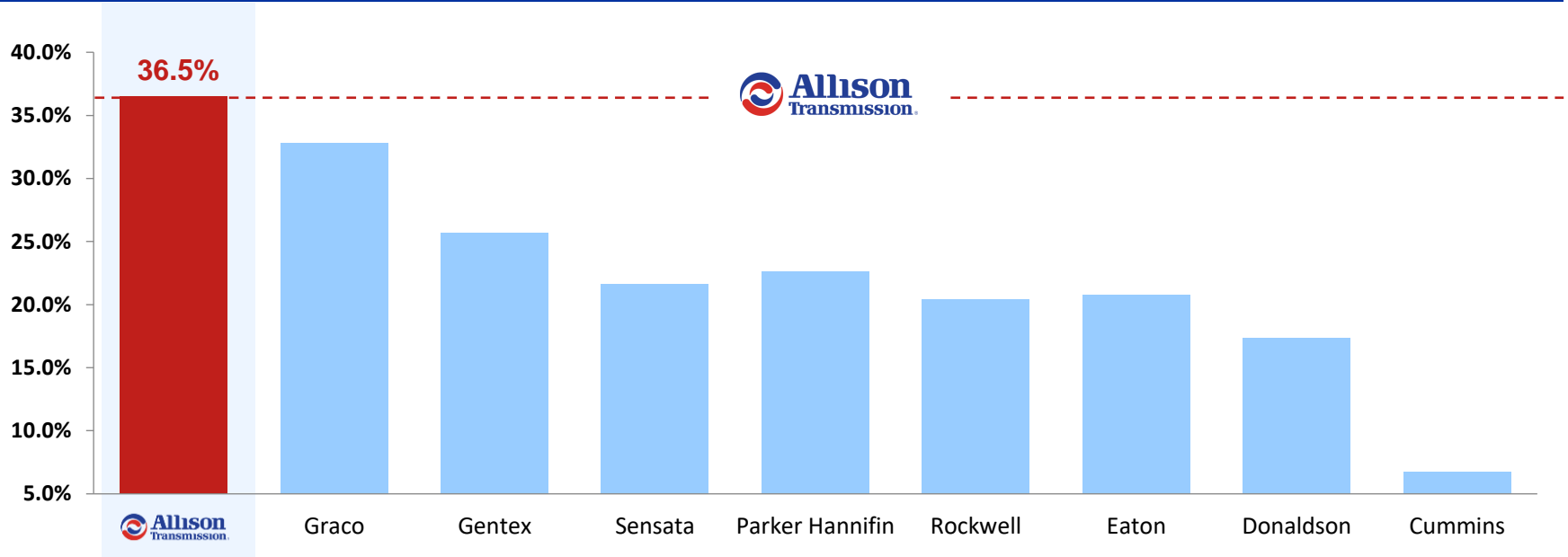

(1) Fiscal year 2023 peer EBITDA provided by S&P Capital IQ Pro. EBITDA included above may not be consistent with such entity's reported EBITDA or Adjusted EBITDA, if available. EBITDA Margin: EBITDA or Adjusted EBITDA divided by net sales. *See appendix for comments regarding the presentation of non-GAAP financial information.



1

Next Generation of Commercial Propulsion

2

New Allison eGen™ Portfolio of Electric Products

3

Allison eGen Power® Electric Axle Solutions

4

Allison eGen Flex® Electric Hybrid Propulsion

5

Allison eGen Force™ Electrified Transmission

Incremental growth opportunities for an established and experienced propulsion supplier such as Allison

- Expertise in commercial propulsion, vehicle controls and vocational duty-cycles
- Deep experience in systems integration, battery management and power distribution
- State-of-the-art product development and testing capabilities
- Established service network
- Allison brand promise of quality, reliability and durability

Positioning Allison to advance the next generation of commercial vehicle propulsion

- Expertise in commercial propulsion, vehicle controls and vocational duty-cycles
- Deep experience in systems integration, battery management and power distribution
 - Fully-Integrated Electric Axles
 - Extended Range Electric Hybrid Propulsion
 - Systems & Battery Management
 - Multi-Speed Centrally Located EV Drives
 - Transmission Integrated Generators
 - Electrification of Accessories

Portfolio of Electric Products



eGEN Power®

- New line of fully-integrated zero-emission electric axles for medium- and heavy-duty commercial trucks
- Release of eGen Power® 85S in October'23 through strategic joint cooperation agreement with Anadolu Isuzu for integration into light-duty truck and midibus platforms for refuse, distribution and public transportation applications
- eGen Power® 100S selected in 2023 as the propulsion solution for Oshkosh Corporation's new fully-integrated, zero-emission electric refuse collection vehicle
- Content per vehicle opportunity of more than 3x compared to a fully automatic transmission



eGEN Flex®

- Next generation zero-emission capable electric hybrid propulsion system
- Enables transit bus fleets to utilize full electric capability without range limitations or infrastructure investment
- Selected by multiple transit authorities across the United States
- Released with major transit OEMs, GILLIG and New Flyer
- Content per vehicle of 10x-15x compared to a fully automatic transmission for transit buses



eGEN Force™

- New electric hybrid propulsion system for tracked combat vehicles
- Designed for 50-ton tracked vehicles, also scalable to 70-ton tracked vehicles meeting future Main Battle Tank requirements
- Power distribution system featuring an electric motor and inverter for on-board vehicle power and parallel hybrid operation
- Engine-off mobility for reduced enemy detection, both acoustic and thermal, increasing soldier survivability
- Leverages use of content from X1100 transmission, used in Abrams Main Battle Tank

eGEN Power®

- One of the most powerful and fully-integrated lines of zero-emission electric axles in the world
- Single and dual electric motor variants with multi-speeds and parallel axis architectures support high starting gradeability, top speed and energy efficiency
- Fully-integrated architectures eliminate many inefficiencies of competitive e-Axle solutions
- Efficiency advantage enhances economic value and range capability
- Development and validation initiatives with major global OEMs
- Designed to fit between the wheels of medium- and heavy-duty trucks and buses

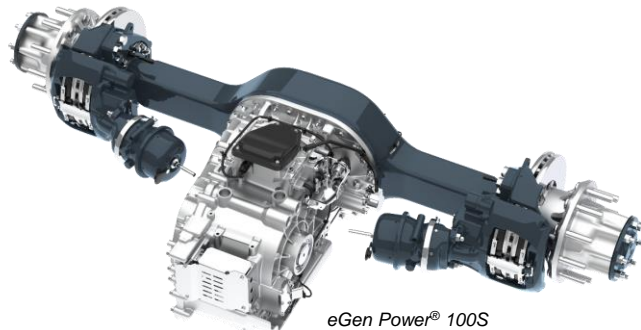

eGen Power® 100S



Oshkosh's McNeilus® Volterra™ ZSL™ electric refuse vehicle will utilize two eGen Power® 100S electric axles in tandem configuration to minimize environmental impact and reduce noise

eGEN Flex[®]

- Over \$1.5 billion in sales since 2003 launch
- Allison's electric hybrid propulsion system for transit buses is among the most dependable and efficient electric hybrid systems in the world
- Demonstrated ability to operate in full engine-off mode for more than 50% of its time in operation across multiple routes
- Drive unit integrates multiple electric motors and multi-speeds to optimize vehicle performance and fuel economy
- Allison is the electrification and system integrator, controlling the entire powertrain including the engine
- 9,500+ Allison electric hybrid propulsion systems delivered globally
 - 388 million gallons of fuel saved
 - Serving 230+ cities
 - 3.3 billion miles of reliable operation



Drive Unit

- Proven industry-leading reliability
- Disconnect clutch to enable disengaging input shaft from the engine
- Provides propulsion while the engine is at zero speed



Inverter

- Improved efficiency
- Improved packaging – one-third the size and 116 lbs. lighter
- WEG cooling – no oil-coolant lines from drive unit, reducing installation complexity and maintenance costs



Rechargeable Energy Storage System

- Lithium Titanate (LTO) chemistry, ideal for electric hybrid operation
- Increased energy capacity
- Industry-leading battery design life
- Faster charging than other chemistries

eGEN Force™

- Newest product in Allison's extensive tracked vehicle portfolio
- Will enable electric hybrid propulsion, electric-only silent maneuverability and exportable power provisions for on- and off-board systems
- High efficiency range pack utilizes eight forward and three reverse gears providing an efficient 12:1 ratio coverage, generating 220 kilowatts of electrical power
- Designed to meet requirements across a broad spectrum of applications, including the heavy Infantry Fighting Vehicle and future Main Battle Tank markets
- Allison will provide the Next-Generation Electrified Transmission propulsion system for American Rheinmetall's Lynx vehicle, competing for the U.S. Army's XM30 Combat Vehicle (formerly, the Optionally Manned Fighting Vehicle) program
 - Strategic partnership with American Rheinmetall Vehicles, and its Team Lynx consortium including Raytheon Technologies, Textron Systems and L3 Harris
- XM30 program is a U.S. Army priority ground modernization initiative that could replace nearly 4,000 Bradley Infantry Fighting Vehicles
- In June 2023, the U.S. Army down-selected from 5 to 2 OEMs, including American Rheinmetall Vehicles, to continue into the Detailed Design and Prototype Build and Testing phases
- Development of prototype vehicles is scheduled to begin mid-November 2024, with government testing beginning in early 2026 and estimated start of production in 2029

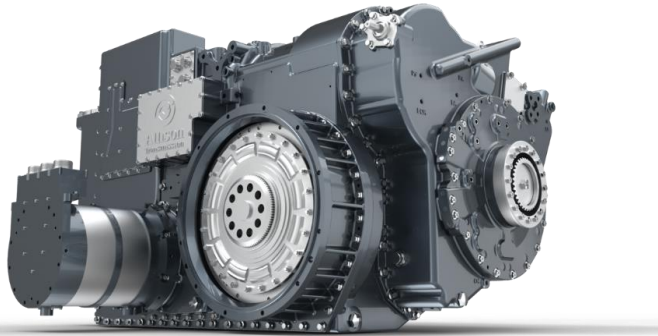



1

Global Market Leader and Premier Brand

2

End User Value Proposition

3

Leader in Commercial Propulsion

4

Diverse End Markets

5

Organic Growth Opportunities

6

Capital Allocation and Free Cash Flow Utilization

A Recognized Leader and Respected Brand



Over 100-year history of providing high-quality innovative products and demonstrated value to end users

Proprietary and patented technology developed over many decades and over eight million global units

End users frequently request Allison Transmission products by name and pay a premium for them



The Allison brand is associated with:

- High Quality
- Reliability
- Durability
- Vocational Value and Expertise
- Technological Leadership
- Superior Customer Service
- Attractive Total Lifecycle Value

Advantages of a fully automatic Allison transmission

Productivity
(acceleration)

Maintenance Savings
(life cycle costs)

Fuel Agnostic and Fuel
Efficiency / Reduced
Emissions

Driver Skillset /
Wages

Training
(time, cost)

Shift Quality

Safety

Residual Value

End Users are Willing to Pay a Premium Price for Allison

Payback period for an Allison Transmission averages less than 3 years

Allison's addressable market encompasses a broad range of vocations with complex and diverse duty-cycles

On-Highway

- Fire and Emergency
- Pick-up, Delivery and Distribution
- Construction
- Refuse
- School, Transit, Shuttle and Coach Bus
- Day Cab Tractors
- Utility
- Motorhome

Off-Highway

- Hydraulic Fracturing
- Oilfield Service and Support
- Rigid Mining Trucks
- Articulated Mining Trucks
- Underground Mining
- Construction
- Agriculture
- Specialty

Defense

- Light / Medium / Heavy Wheeled
 - US: JLTV, FMTV, HEMTT, Stryker
 - Other: Jackal, Eitan, Boxer IFV, Tigon
- Light / Medium / Heavy Tracked
 - US: M1 Abrams, M88A3, M10 Booker
 - Other: K9, Krab, AS21 Redback, K200 KIFV

Vocational diversity results in a complex application space that requires a range of propulsion solutions where Allison is a natural supplier

- Internal combustion engine applications
- Alternative fuel vehicles, including natural gas and propane, with proven performance advantages and a funded infrastructure
- Electric hybrid systems, including flexible hybrid, range extender and plug-in options
- Full electric solutions, including hydrogen fuel cell and battery electric applications

Very Diverse End Markets

	Distribution	Emergency	Motorhome	Rugged Duty	School/Shuttle Bus	Transit
Global	 	 	 	 	 	
Defense	 	 				

Over 350 OEMs Rely on Allison for Vehicle Propulsion Solutions



North America	On-Highway	
	Transit Bus	
	Off-Highway	
Outside North America	On-Highway	
	Off-Highway	
Defense	Light / Medium / Heavy Wheeled and Tracked	



1

\$400M of Incremental Annual Revenue Opportunities

2

Outside North America On-Highway Growth Strategy

3

Global Off-Highway Growth Strategy

4

North America On-Highway Growth Strategy

5

Global Defense Growth Strategy

6

Value Added On-Highway Variants & Enhancements

Wide Body Mining Dump

- Penetration of new market for Allison's 4000 Series™ and 6000 Series™ On-Highway transmissions
- ALSN is released in all OEMs operating in the WBMD truck market
- Gaining market share in Chinese domestic market and export markets globally including India, South America, Africa and Indonesia
- **Represents \$100M of incremental annual revenue opportunity**

FracTran®

- Next-generation, designed-from-the-ground-up Oil Field Series™ (OFS) transmission, purpose-built for hydraulic fracturing applications to maximize customer productivity with high reliability and powerful performance
- Dual fuel compatibility for natural gas-powered engines, increased horsepower ratings and substantially reduced idle time
- Introduced in 2021 and currently being tested in multiple oilfield fleets across the United States and Canada. Start of production began in mid-2023.
- **Represents \$100M of incremental annual revenue opportunity**

Class 8 Day Cab and Regional Haul Tractor Market

- Allison 4000 Series™ transmission and 3414 Regional Haul Series™ transmission, an uprated variant of Allison's proven 3000 Series™ fully automatic transmission designed to support the higher engine and torque requirements of Distribution and Regional Haul Class 8 Day Cab tractors
- Lighter than competitive automated manual transmissions, and providing fleets with 25% faster acceleration and up to 8% fuel economy improvement
- Secured releases with top OEMs, including vertically integrated OEMs, such as International, Daimler and Volvo
- **Represents \$100M of incremental annual revenue opportunity**

Defense End Market

- Growth opportunity based on increased global defense spending due to shifts in geopolitical dynamics, the war in Ukraine and US DoD modernization priorities
- Maintain long-standing relationship with US DoD with primary opportunity in tracked vehicle programs and international growth accomplished through:
 - Expansion of sales of existing products to international allies
 - Growing relationships with global defense OEMs
 - New products and variants gaining interest globally
- **Represents \$100M of incremental annual revenue opportunity**

Total of \$400M of Annual Incremental Revenue Opportunities

Outside North America On-Highway Growth Strategy



Global market leadership expansion and emerging markets penetration

- Substantial investments in the expansion of global sales presence
- Ongoing OEM release activities
- Targeted end user initiatives drive demand for the Allison brand
- Facilitates service channel build out in developing markets
- Labor availability of skilled drivers poses opportunity for further penetration of automatic transmissions

Demand drivers vary by region

- Increasing vehicle sophistication
- Stricter emissions, fuel economy and safety standards
- Growing demand for productivity improvements
- Micro and demographic trends
- Focus on reducing lifecycle costs

Focus on high value vocational vehicles

- Transit, refuse, fire & emergency, airport support, terminal tractors, dock spotters, mining and oil field support, construction, etc.
- Cost of vehicle downtime is high
- Enhanced value proposition supported by 2-3 year payback period

5 years of consecutive revenue growth pre-COVID in Outside North America On-Highway, followed by full-year record-setting net sales in 2022 and 2023

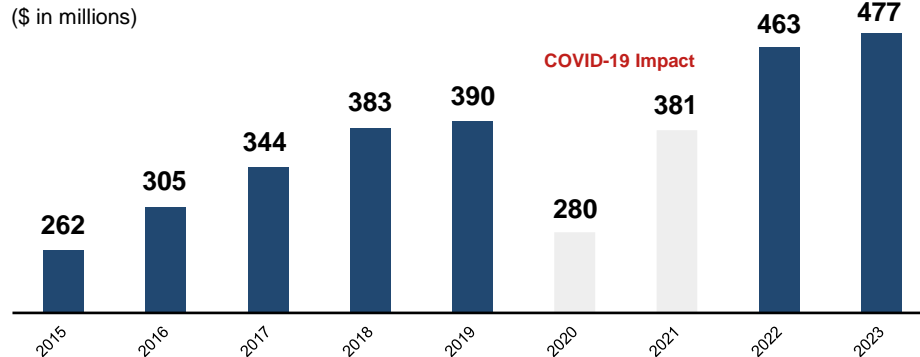

Wide Body Mining Dump Truck market represents growth opportunity of \$100 million in incremental annual revenue



Global Off-Highway Growth Strategy



Energy Sectors

- Demand expected to be less cyclical with continued supply issues solved by multi-year investments
- Investments for energy security driven by national security threats
- Market tightness remains with capital discipline and limited equipment availability
- Continued investments in differentiated and higher horsepower solutions

High Horsepower Hydraulic Fracturing Transmissions

- Launched FracTran® in 2021, purpose-built to meet the harsh demands of global oil and gas fields
- Addressing global market demand for higher horsepower, extended duty-cycles, lower days-to-depth, higher recovery factors and smaller footprints
- New OFS models based on six decades of industry expertise

Mining and Construction

- Considerable end market cyclical, recovering from trough levels due to pent up demand and aging fleets
- Commodity prices support further expansion projects and continued demand
- Global economic recovery and increasing global urbanization and sustainability initiatives, driving increased construction activity and raw material demand

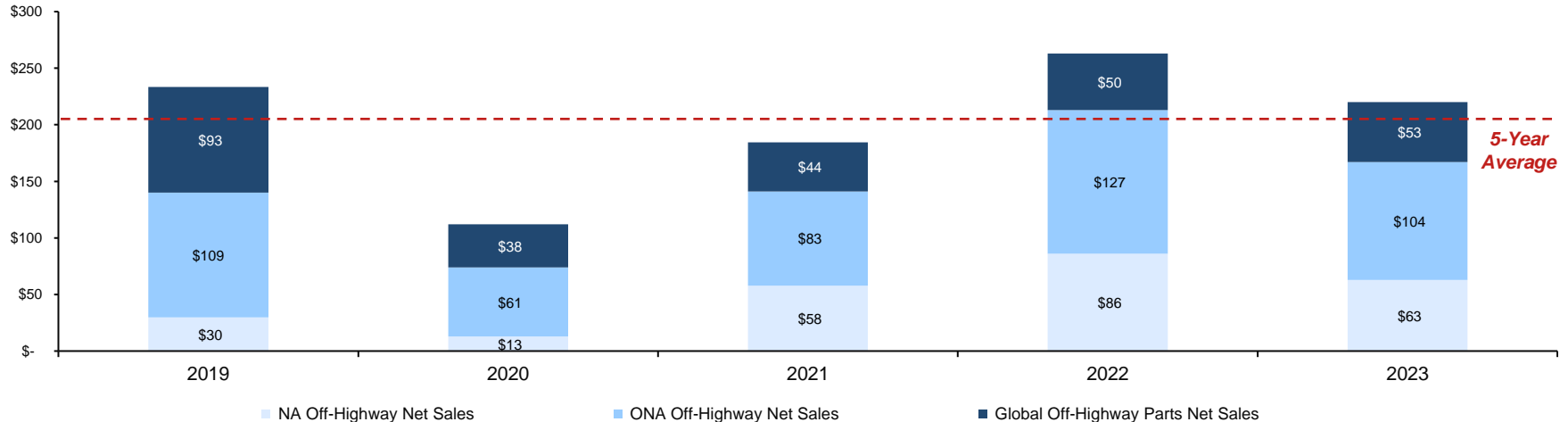

North America On-Highway Growth Strategy



- Unprecedented demand for Class 8 vocational vehicles driven by infrastructure spending with industry supply chain challenged by robust volumes

- Structural growth drivers remain intact

- Relative stability of Class 6/7 medium-duty market
- Continued growth in first and last mile delivery sector
- Increasing demand for fuel efficient vehicles

- Increased penetration opportunities

- Growth opportunity of \$100 million in incremental annual revenue in the Class 8 Regional Haul Day Cab market with the Allison 4000 Series™ fully automatic transmission and 3414 Regional Haul Series™ (RHS)
- 3414 RHS launched with International in 2020, Daimler Trucks North America (paired with diesel engine) and Volvo Trucks North America in 2021, and further release with Daimler Trucks North America for CNG engine in 2023
- In 2023, the 3414 RHS was specified by one of the largest global logistics and delivery companies as the propulsion solution in additional CNG Freightliner Cascadia Day Cab tractors added to its fleet
- All-New Mack MD Series line of medium-duty trucks and Isuzu F-Series Class 6/7 models, exclusive with the Allison fully automatic transmission
- Class 4/5 commercial trucks launched by Chevrolet, International and Isuzu, exclusively with the Allison fully automatic transmission

North America Production in Allison's Core Addressable Market (units in 000s)⁽¹⁾

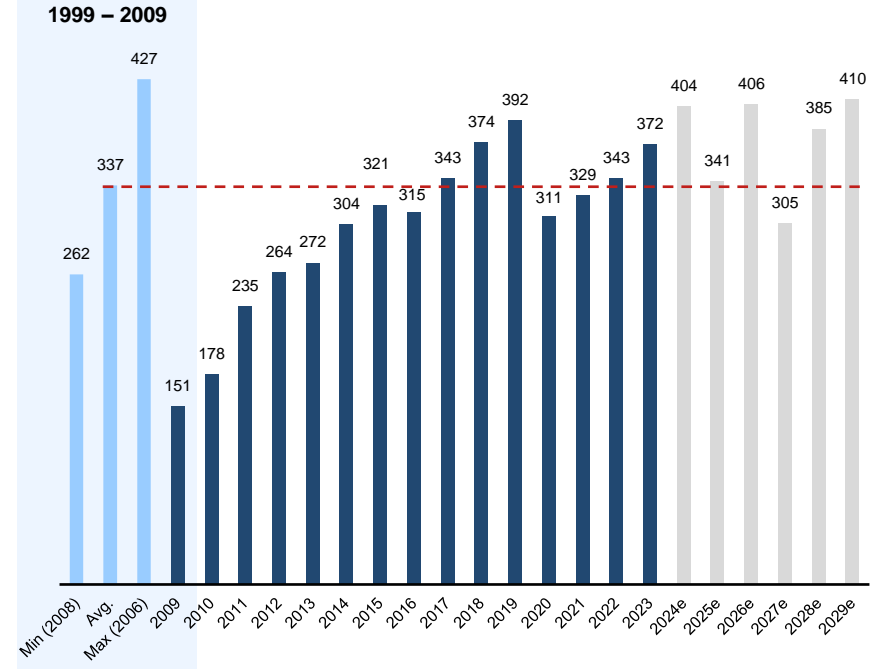

(1) Source: ACT Research, October 2024. Includes: Class 4 through 8 less Class 8 Tractor & Class 8 Straight with Sleeper. 2024: Total 623,813 less Class 8 Tractor of 215,558 less Class 8 Straight with Sleeper of 4,282.

- Allison is committed to investing in and pursuing opportunities resulting from increased global defense spending in a multi-year growth cycle representing a \$100 million incremental annual revenue opportunity over the next few years
- Poised to capture growth through continuation of long-standing partnership with United States Department of Defense and diversifying revenue through increased international defense sales
- Opportunities for future long-term growth including eGen Force™ electric hybrid propulsion system for tracked combat vehicles. The eGen Force™ system has been selected by American Rheinmetall for their XM30 offering.

United States

- Allison provides transmissions to the US Department of Defense for all wheeled vehicles heavier than the Humvee and more than half of the armored combat vehicles used by the US Military
- Expectation of substantial growth in tracked vehicle programs including the Army's M10 Booker light tank (formerly MPF), the M88A3 recovery vehicle and the continuation of the Abrams Main Battle Tank contract
- Growth and sustainment for numerous wheeled vehicle programs including the continuation of the JLTV program



International

- Opportunities through expansion of sales of existing products
 - US Government planning to sell over 300 X1100 transmissions for FMS Abrams Main Battle Tank sales over the next 3 years to Australia, Poland and Romania
- Increased relationships with global defense OEMs
 - Growing relationship with South Korea's Hanwha Aerospace as Allison's largest defense OEM
 - Hanwha's K9 Thunder Self-Propelled Howitzer planned sales to Egypt and Poland and further global opportunity with Hanwha's new Redback Infantry Fighting Vehicle, selected for Australia's LAND 400 program
- Development of new products and product variants driving growth
 - Allison's new 3040 MX and 4040 MX medium-weight cross-drive transmissions
 - 3040 MX selected by US Army for the M10 Booker program and by India for their FICV (Future Infantry Combat Vehicle) as well as programs in Turkey and Poland
 - 4040 MX selected by BAE Systems Hägglunds for CV90 Infantry Fighting Vehicle programs
- Allison's X1100 variant developed for the Turkish Firtina Self-Propelled Howitzer program

FuelSense® 2.0

- Proprietary software launched in 2017, ideally suited for shift dense vocations such as transit, school bus, refuse, construction and distribution
- DynActive® Shifting utilizes learning algorithm to continuously find the ideal balance of fuel economy and performance
- Neutral at Stop trims fuel consumption and emissions by reducing load on the engine when the vehicle is stopped
- Acceleration Rate Management limits vehicle acceleration to a customized calibrated rate

9-Speed Transmission

- New design leverages the proven reliability of the Allison six-speed 2000 Series™
- New benchmark in fuel efficiency and reduced emissions standards
- Significant fuel savings due to deep first gear ratio, industry leading ratio coverage and advanced engine stop-start capability
- Improved driver comfort and acceleration, allowing for a smoother launch and increased productivity

xFE Models

- New transmissions with redesigned torque converter damper, optimized gear ratios and coupled with FuelSense® Max packages
- Represents the latest in fuel savings innovation
 - Fuel savings of up to 7% over comparatively equipped models with FuelSense® features
 - Best fuel economy from an automatic transmission
- Available in the 1000, 2000 and 3000 Series™ fully automatic transmission models

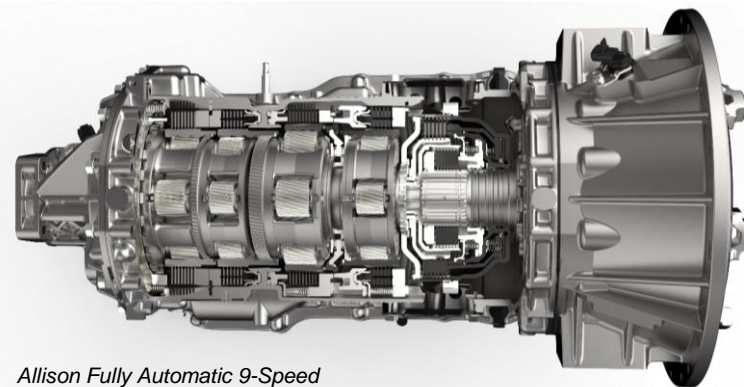

Allison Fully Automatic 9-Speed

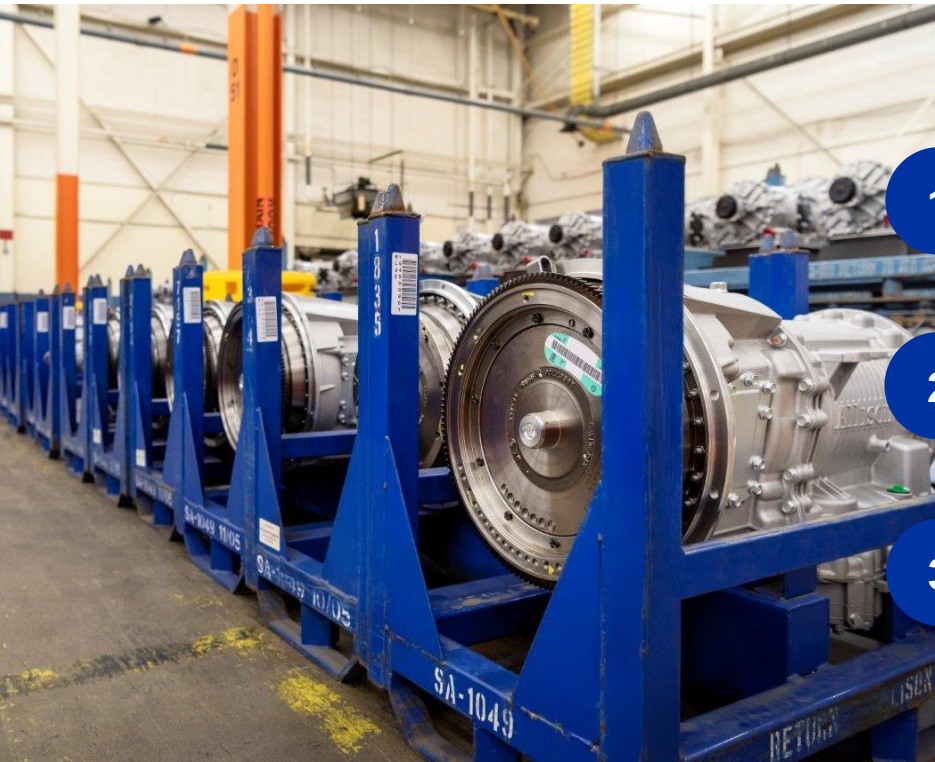

1

Significant Cash Flow Generation

2

Capital Allocation Priorities

3

Free Cash Flow Utilization

Significant Cash Flow Generation



Adj. Free Cash Flow Generation⁽¹⁾

(\$ in millions)

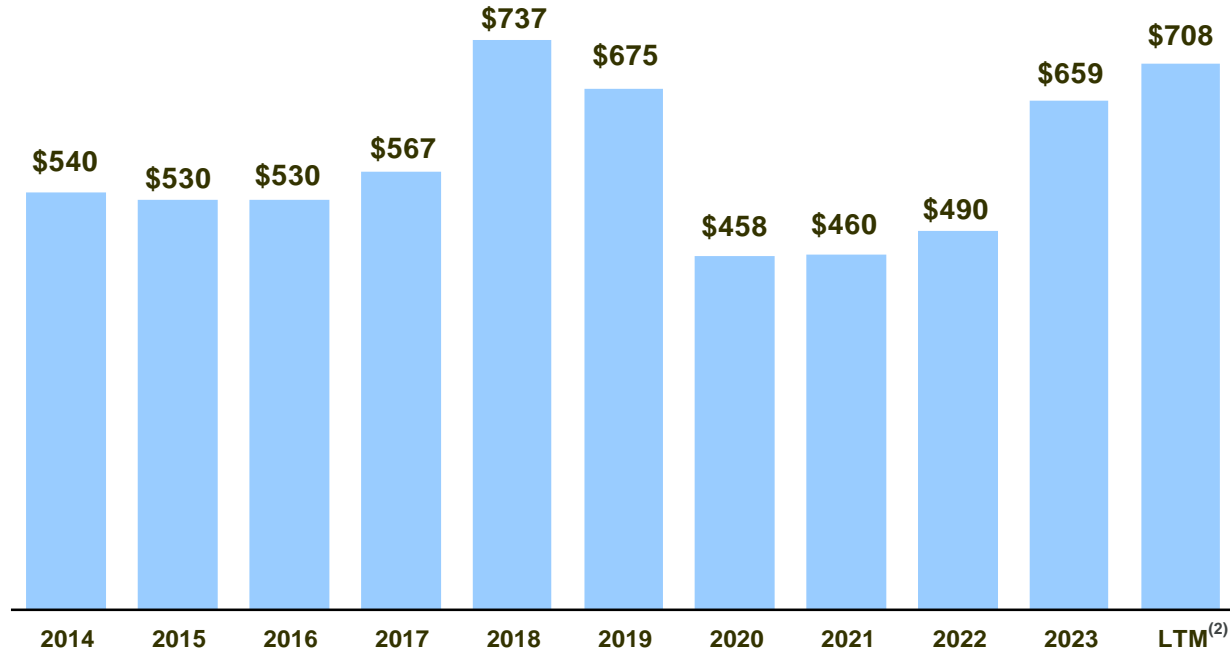

Note: See appendix for comments regarding the presentation of non-GAAP financial information.

(1) See appendix for a reconciliation of Adjusted Free Cash Flow.

(2) LTM 9/30/24

Capital Allocation Priorities



- Organic revenue and earnings growth
- New product and technology development
- Strategic acquisition opportunities
- Return of capital to shareholders
- Prudent balance sheet management
- Low-cost, flexible and pre-payable debt structure with long dated maturities
- As of 9/30/24, over 63% of shares outstanding repurchased since IPO with \$0.6B of share repurchase authorization remaining
- Increased quarterly dividend by 67% in the last 5 years

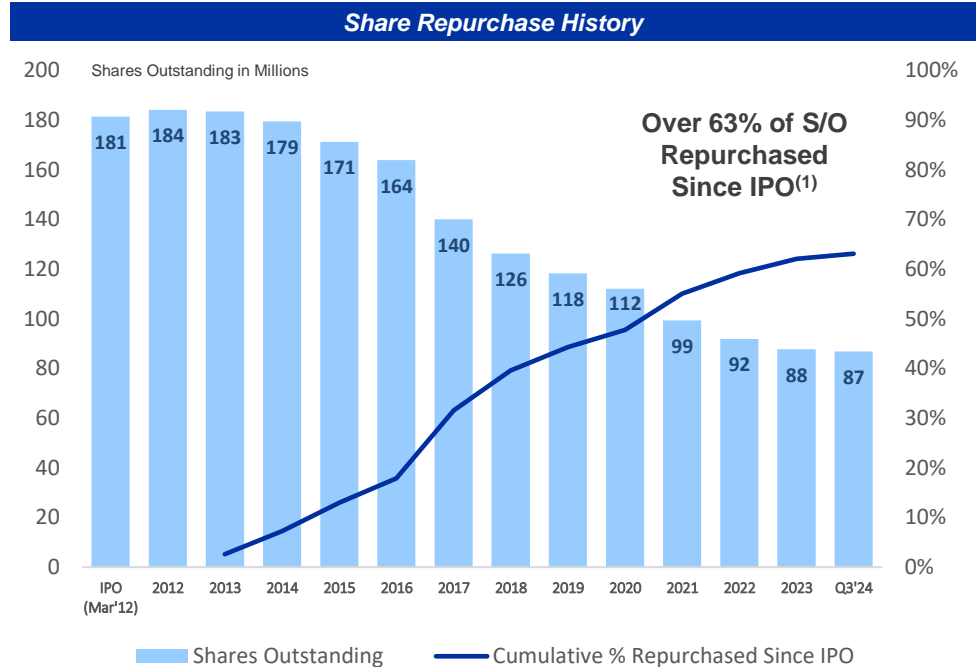

(1) Repurchased ~114M shares outstanding as of 9/30/24

Free Cash Flow Utilization



Note: See appendix for comments regarding the presentation of non-GAAP financial information.

(1) Net of change in Cash & Cash Equivalents

(2) 2009 adjusted for certain non-recurring activity: (a) capitalized accrued interest on Senior Toggle Notes (\$29) million, (b) cash restructuring charge \$51 million, (c) accounts payable early payments \$3 million, (d) delayed accounts receivable receipts \$19 million and (e) Lehman LIBOR swap settlement \$17 million. All periods adjusted for collateral for interest rate derivatives, purchase of available-for-sale securities, proceeds from disposal of assets, investments in technology-related initiatives and license expenses, and fee to terminate services agreement with Sponsors.

(3) \$639 million of authorized share repurchase capacity remaining as of 9/30/24

(4) LTM 9/30/24

Well-Defined Capital Allocation Policy

- Realize returns from completed investments in global commercial capabilities, and new product and technology development
- Prudent balance sheet management
- Return capital to shareholders
 - Quarterly dividend of \$0.25 per share in Q3 2024
 - Share repurchase authorization increased by \$1.0 billion to \$4.0 billion in Q1 2022⁽³⁾
- Low-cost, flexible and pre-payable debt structure with long dated maturities



Financial Overview

Allison Financial Highlights



- Solid operating margins
 - End Markets diversity
 - Premium vocational pricing model
 - Cost controls and productivity improvements
- Low recurring (maintenance) capital expenditure requirements
- Positioned for long-term cash earnings growth
 - Multiple growth opportunities in asset-light business model
- Strong free cash flow

(1) LTM 9/30/24
(2) Adjusted EBITDA margin: Adjusted EBITDA divided by net sales.

Note: See appendix for comments regarding the presentation of non-GAAP financial information.

LTM⁽¹⁾ Financial Metrics

(% of Net Sales)

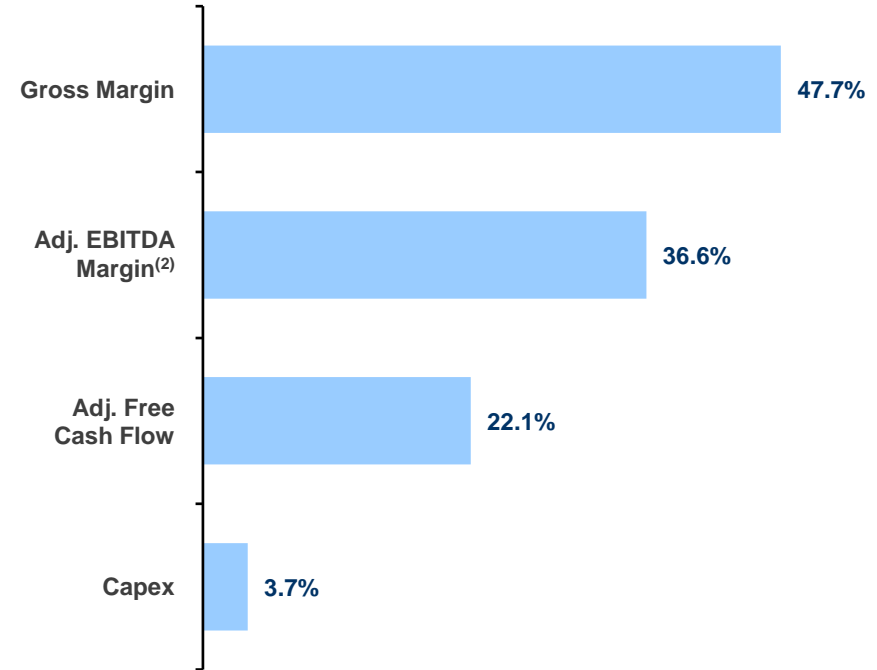

Strong Liquidity Profile



- Amend and extend of revolver and term loan on March 13, 2024
 - Increased commitments under revolving credit facility from \$650 million to \$750 million and extended maturity to March 13, 2029
 - Refinanced \$518 million of term loan debt, paid down \$101 million of existing term loan debt, extended maturity to March 13, 2031 and removed 0.10% credit spread adjustment while maintaining SOFR+175 interest rate
- Cash and Available Borrowing Capacity of \$1.5 billion as of September 30, 2024
 - \$788 million of cash and cash equivalents
 - \$745 million of available revolving credit facility commitments
- History of robust free cash flow generation
- Staggered, flexible, long-dated and covenant light debt structure with the earliest maturity due in October 2027
 - As of September 30, 2024, Allison held interest rate swaps that effectively hedge \$500 million of the variable rate debt associated with the Term Loan B through September 2025
- Financial Covenants point to First Lien Net Leverage Ratio
 - Maximum threshold of 5.5x First Lien Net Leverage ratio (Net First Lien Debt to LTM Adj. EBITDA)
 - First Lien Net Leverage ratio of -0.23x as of September 30, 2024
- Net Leverage ratio of 1.39x (Net Debt to LTM Adj. EBITDA) as of September 30, 2024
- Capital Allocation
 - Increased quarterly dividend to \$0.25 per share in Q1 2024, the fifth consecutive year of dividend increases
 - Repurchased over \$50 million of outstanding shares in third quarter 2024, with over 63% of outstanding shares repurchased since IPO in 2012

Long-Term Debt Profile & Credit Statistics

<i>(in millions)</i>	9/30/2024
Cash and cash equivalents	\$788
Revolving Credit Facility due Mar 2029	\$0
Senior Secured Term Loan B due Mar 2031	\$515
Total First Lien Debt	\$515
Senior Notes due Oct 2027 (Fixed 4.75%)	\$400
Senior Notes due Jun 2029 (Fixed 5.875%)	\$500
Senior Notes due Jan 2031 (Fixed 3.75%)	\$1,000
Total Debt	\$2,415
Net Debt	\$1,627
First Lien Net Debt	-\$273
Credit Statistics:	
LTM Adjusted EBITDA	\$1,172
First Lien Net Leverage Ratio	-0.23x
Net Leverage Ratio	1.39x

Current Debt Maturity Profile

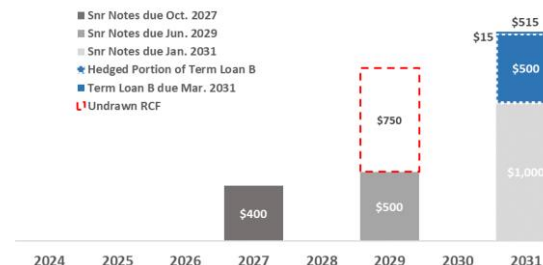

Allison Transmission is the global leader in the markets it serves

- Premier fully automatic transmission brand
- Established supplier of fully-integrated, commercial-duty electrified propulsion systems
- Over 100-year operating history

Strong financial position

- Elite EBITDA margin
- Asset-light business model
- Significant free cash flow generation
- Returning capital to shareholders

Substantial growth opportunities

- Expand global leadership
- Penetrate emerging markets
- Address underserved markets
- Continuous product innovation



Guidance/ Supplemental Financial Data

2024 Guidance Update



(\$ in millions)

Increasing full year 2024 guidance previously provided to the market on July 25, 2024

\$3,135 - \$3,215	\$675 - \$725	\$1,115 - \$1,175	\$740 - \$800	\$135 - \$145	\$605 - \$655
Net Sales	Net Income	Adjusted EBITDA*	Net Cash Provided by Operating Activities	Capital Expenditures	Adjusted Free Cash Flow*

Net sales guidance reflects higher net sales driven by price increases on certain products, increased North America On-Highway and Defense end market demand and the continued execution of growth initiatives.

*See Appendix for the Guidance Reconciliation

Financial Summary

In \$ millions	LTM ⁽¹⁾										
	2014	2015	2016	2017	2018	2019	2020	2021	2022	2023	2024
Net Sales	\$2,127	\$1,986	\$1,840	\$2,262	\$2,713	\$2,698	\$2,081	\$2,402	\$2,769	\$3,035	\$3,204
% Growth	10.4%	(6.7%)	(7.3%)	22.9%	19.9%	(0.6%)	(22.9%)	15.4%	15.3%	9.6%	7.6%
Adj. EBITDA ⁽²⁾	745	720	644	868	1,128	1,083	732	844	961	1,108	1,172
% of Net Sales	35.0%	36.3%	35.0%	38.4%	41.6%	40.1%	35.2%	35.1%	34.7%	36.5%	36.6%
Total CapEx	64	58	71	91	100	172	115	175	167	125	120
% of Net Sales	3.0%	2.9%	3.8%	4.0%	3.7%	6.4%	5.5%	7.3%	6.0%	4.1%	3.7%
Adj. Free Cash Flow	540	530	530	567	737	675	458	460	490	659	708
% of Net Sales	25.4%	26.7%	28.8%	25.1%	27.2%	25.0%	22.0%	19.2%	17.7%	21.7%	22.1%

Note: See appendix for comments regarding the presentation of non-GAAP financial information.

(1) LTM 9/30/24

(2) Excluding technology-related license expenses in 2014 of \$6 million.

Allison Quarterly Sales Summary



Quarterly Net Sales by End Market (\$ in millions)

Net Sales	2016					2017					2018				
	Q1	Q2	Q3	Q4	Total	Q1	Q2	Q3	Q4	Total	Q1	Q2	Q3	Q4	Total
NA On-Highway	\$274	\$280	\$232	\$237	\$1,023	\$275	\$314	\$301	\$287	\$1,177	\$339	\$343	\$332	\$303	\$1,317
NA Off-Highway	\$5	\$1	\$1	\$0	\$7	\$1	\$5	\$17	\$28	\$51	\$33	\$31	\$12	\$17	\$93
Defense	\$25	\$28	\$25	\$37	\$115	\$27	\$30	\$35	\$25	\$117	\$37	\$43	\$42	\$36	\$158
ONA On-Highway	\$70	\$74	\$78	\$83	\$305	\$72	\$85	\$89	\$98	\$344	\$91	\$101	\$96	\$95	\$383
ONA Off-Highway	\$3	\$3	\$2	\$4	\$12	\$6	\$10	\$14	\$11	\$41	\$12	\$24	\$46	\$47	\$129
Parts, Support Equipment & Other	\$85	\$89	\$96	\$108	\$378	\$118	\$136	\$139	\$139	\$532	\$151	\$169	\$164	\$149	\$633
Total Net Sales	\$462	\$475	\$434	\$469	\$1,840	\$499	\$580	\$595	\$588	\$2,262	\$663	\$711	\$692	\$647	\$2,713
Net Sales	2019					2020					2021				
	Q1	Q2	Q3	Q4	Total	Q1	Q2	Q3	Q4	Total	Q1	Q2	Q3	Q4	Total
NA On-Highway	\$377	\$398	\$369	\$330	\$1,474	\$352	\$164	\$281	\$284	\$1,081	\$319	\$302	\$275	\$281	\$1,177
NA Off-Highway	\$14	\$9	\$6	\$1	\$30	\$8	\$3	\$1	\$1	\$13	\$2	\$9	\$20	\$27	\$58
Defense	\$32	\$37	\$40	\$42	\$151	\$40	\$42	\$56	\$44	\$182	\$45	\$48	\$39	\$54	\$186
ONA On-Highway	\$94	\$106	\$99	\$91	\$390	\$72	\$60	\$71	\$77	\$280	\$84	\$98	\$93	\$106	\$381
ONA Off-Highway	\$27	\$40	\$24	\$18	\$109	\$27	\$19	\$4	\$11	\$61	\$16	\$18	\$14	\$35	\$83
Parts, Support Equipment & Other	\$131	\$147	\$131	\$135	\$544	\$138	\$89	\$119	\$118	\$464	\$122	\$128	\$126	\$141	\$517
Total Net Sales	\$675	\$737	\$669	\$617	\$2,698	\$637	\$377	\$532	\$535	\$2,081	\$588	\$603	\$567	\$644	\$2,402
Net Sales	2022					2023					2024				
	Q1	Q2	Q3	Q4	Total	Q1	Q2	Q3	Q4	Total	Q1	Q2	Q3	LTM	
NA On-Highway	\$346	\$340	\$340	\$333	\$1,359	\$376	\$397	\$376	\$380	\$1,529	\$420	\$456	\$457	\$1,713	
NA Off-Highway	\$18	\$20	\$24	\$24	\$86	\$24	\$25	\$9	\$5	\$63	\$4	\$1	\$1	\$11	
Defense	\$35	\$29	\$35	\$47	\$146	\$27	\$33	\$43	\$63	\$166	\$48	\$43	\$53	\$207	
ONA On-Highway	\$109	\$105	\$118	\$131	\$463	\$108	\$123	\$118	\$128	\$477	\$115	\$128	\$126	\$497	
ONA Off-Highway	\$30	\$32	\$36	\$29	\$127	\$23	\$24	\$19	\$38	\$104	\$42	\$22	\$19	\$121	
Parts, Support Equipment & Other	\$139	\$138	\$157	\$154	\$588	\$183	\$181	\$171	\$161	\$696	\$160	\$166	\$168	\$655	
Total Net Sales	\$677	\$664	\$710	\$718	\$2,769	\$741	\$783	\$736	\$775	\$3,035	\$789	\$816	\$824	\$3,204	



Appendix

Non-GAAP Financial Information

Appendix: Non-GAAP Financial Information

We use Adjusted EBITDA and Adjusted EBITDA as a percent of net sales to measure our operating profitability. We believe that Adjusted EBITDA and Adjusted EBITDA as a percent of net sales provide management, investors and creditors with useful measures of the operational results of our business and increase the period-to-period comparability of our operating profitability and comparability with other companies. Adjusted EBITDA as a percent of net sales is also used in the calculation of management's incentive compensation program. The most directly comparable U.S. generally accepted accounting principles ("GAAP") measure to Adjusted EBITDA and Adjusted EBITDA as a percent of net sales is Net income and Net income as a percent of net sales, respectively. Adjusted EBITDA is calculated as the earnings before interest expense, net, income tax expense, amortization of intangible assets, depreciation of property, plant and equipment and other adjustments as defined by Allison Transmission, Inc.'s, the Company's wholly-owned subsidiary, Second Amended and Restated Credit Agreement. Adjusted EBITDA as a percent of net sales is calculated as Adjusted EBITDA divided by net sales.

We use Adjusted Free Cash Flow to evaluate the amount of cash generated by our business that, after the capital investment needed to maintain and grow our business and certain mandatory debt service requirements, can be used for repayment of debt, stockholder distributions and strategic opportunities, including investing in our business. We believe that Adjusted Free Cash Flow enhances the understanding of the cash flows of our business for management, investors and creditors. Adjusted Free Cash Flow is also used in the calculation of management's incentive compensation program. The most directly comparable GAAP measure to Adjusted Free Cash Flow is Net cash provided by operating activities. Adjusted Free Cash Flow is calculated as Net cash provided by operating activities, excluding non-recurring restructuring charges, after additions of long-lived assets.

Non-GAAP Reconciliations (1 of 3)

Adjusted EBITDA Reconciliation

\$ in millions, Unaudited											Last twelve months ended September 30
	2014	2015	2016	2017	2018	2019	2020	2021	2022	2023	2024
Net income (GAAP)	\$229	\$182	\$215	\$504	\$639	\$604	\$299	\$442	\$531	\$673	\$726
plus:											
Income tax expense	139	107	126	23	166	164	94	130	114	154	167
Depreciation of property, plant and equipment	94	88	84	80	77	81	96	104	109	109	110
Interest expense, net	138	114	101	103	121	134	137	116	118	107	92
Amortization of intangible assets	99	97	92	90	87	86	52	46	46	45	20
Stock based compensation expense	15	10	9	12	13	13	17	14	18	22	25
UAW Local 933 contract signing incentives	—	—	—	10	—	—	—	—	—	—	14
Unrealized loss on marketable securities	—	—	—	—	—	—	—	—	22	1	10
Pension plan settlement loss	—	—	—	—	—	—	—	—	—	—	4
Technology-related investment expenses	2	—	1	16	3	—	—	(3)	(6)	(3)	1
Unrealized loss on foreign exchange	5	1	1	—	3	—	2	—	6	—	1
Impairments of long-lived assets	15	1	—	32	4	2	—	—	—	—	1
Equity earnings in equity method investments	—	—	—	—	—	—	—	—	—	—	1
Environmental remediation	—	14	—	—	—	(8)	—	—	—	—	—
Loss on redemptions and repayments of long-term debt	1	1	—	—	—	—	—	—	—	—	—
Stockholder activism expenses	—	—	4	—	—	—	—	—	—	—	—
Dual power inverter module extended coverage	1	(2)	1	(2)	—	—	—	—	—	—	—
UAW Local 933 retirement incentive	—	—	—	—	15	5	7	(2)	—	—	—
Trade name impairments	—	80	—	—	—	—	—	—	—	—	—
Unrealized loss on commodity hedge contracts	(1)	1	(2)	—	—	—	—	—	—	—	—
Expenses related to long-term debt refinancing	—	25	12	—	—	1	13	—	—	—	—
Restructuring charges	1	—	—	—	—	—	14	(4)	—	—	—
Other, net	(111)	20	—	—	—	1	1	1	3	—	—
Adjusted EBITDA (non-GAAP)	\$627	\$739	\$644	\$868	\$1,128	\$1,083	\$732	\$844	\$961	\$1,108	\$1,172
Net Sales (GAAP)	\$2,127	\$1,986	\$1,840	\$2,262	\$2,713	\$2,698	\$2,081	\$2,402	\$2,769	\$3,035	\$3,204
Net income as a percent of net sales	10.8%	9.2%	11.7%	22.3%	23.6%	22.4%	14.4%	18.4%	19.2%	22.2%	22.7%
Adjusted EBITDA as a percent of net sales	29.5%	36.2%	35.0%	38.4%	41.6%	40.1%	35.2%	35.1%	34.7%	36.5%	36.6%

Non-GAAP Reconciliations (2 of 3)



Adjusted Free Cash Flow Reconciliation

	2014	2015	2016	2017	2018	2019	2020	2021	2022	2023	Last twelve months ended September 30, 2024
\$ in millions, Unaudited											
Net Cash Provided by Operating Activities (GAAP)	\$573	\$580	\$591	\$658	\$837	\$847	\$561	\$635	\$657	\$784	\$828
(Deductions) or Additions:											
Long-lived assets	(64)	(58)	(71)	(91)	(100)	(172)	(115)	(175)	(167)	(125)	(120)
Restructuring charges	—	—	—	—	—	—	12	—	—	—	—
Technology-related license expenses	6	—	—	—	—	—	—	—	—	—	—
Stockholder activism expenses	—	—	4	—	—	—	—	—	—	—	—
Excess tax benefit from stock-based compensation	25	8	6	—	—	—	—	—	—	—	—
Adjusted Free Cash Flow (non-GAAP)	\$540	\$530	\$530	\$567	\$737	\$675	\$458	\$460	\$490	\$659	\$708

Guidance Reconciliation

\$ in millions	Guidance	
	Year Ending December 31, 2024	
	Low	High
Net Income (GAAP)	\$ 675	\$ 725
plus:		
Income tax expense	170	180
Depreciation of property, plant and equipment	113	113
Interest expense, net	90	90
Amortization of intangible assets	11	11
Stock-based compensation expense	26	26
UAW Local 933 contract signing incentives	14	14
Unrealized loss on marketable securities	8	8
Pension plan settlement loss	4	4
Unrealized loss on foreign exchange	1	1
Equity in earnings of equity method investments	1	1
Technology-related investments loss	1	1
Loss associated with impairment of long-lived assets	1	1
Adjusted EBITDA (Non-GAAP)	\$ 1,115	\$ 1,175
Net Cash Provided by Operating Activities (GAAP)	\$ 740	\$ 800
Deductions to Reconcile to Adjusted Free Cash Flow:		
Additions of long-lived assets	\$ (135)	\$ (145)
Adjusted Free Cash Flow (Non-GAAP)	\$ 605	\$ 655

Certain Trademarks

This presentation contains trademarks, service marks, copyrights and trade names of other companies, which are the property of their respective owners. We do not intend our use or display of other companies' trademarks, service marks, copyrights or trade names to imply a relationship with, or endorsement or sponsorship of us by, any other companies.